

Notice technique de montage Ecran de cantonnement

Technical instructions for the installation of Smoke barrier

Smoke Fix

Outillage à prévoir

Tools to be provided



Visseuse
Drill machine



Crayon
Pencil



Cutter
Cutter



Nacelle ciseaux
Scissorlifts



Mètre ruban
Tape measure



Equerre
Set square



Ciseaux
Scissors









2 personnes
2 persons

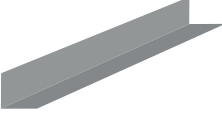

Douille de 10
Clamping bush (10)

Fourniture Bluetek

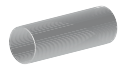
Provided by Bluetek

	Fournitures	Qté
A	 <p>Cornières 40 x 40 x 1,2mm (longueur 2,00m)</p>	
B	 <p>Vis hexagonale autoforeuse (6x16mm) avec rondelle</p>	
C	 <p>Toile souple (écran de cantonnement). Détails page 4.</p>	
D	 <p>Barre de lestage Ø 16mm (longueur 2,00m)</p>	
E	 <p>Manchon pour barres de lestage Ø 17mm (longueur 0,3 m)</p>	
F	 <p>Adhésif (pour les finitions)</p>	

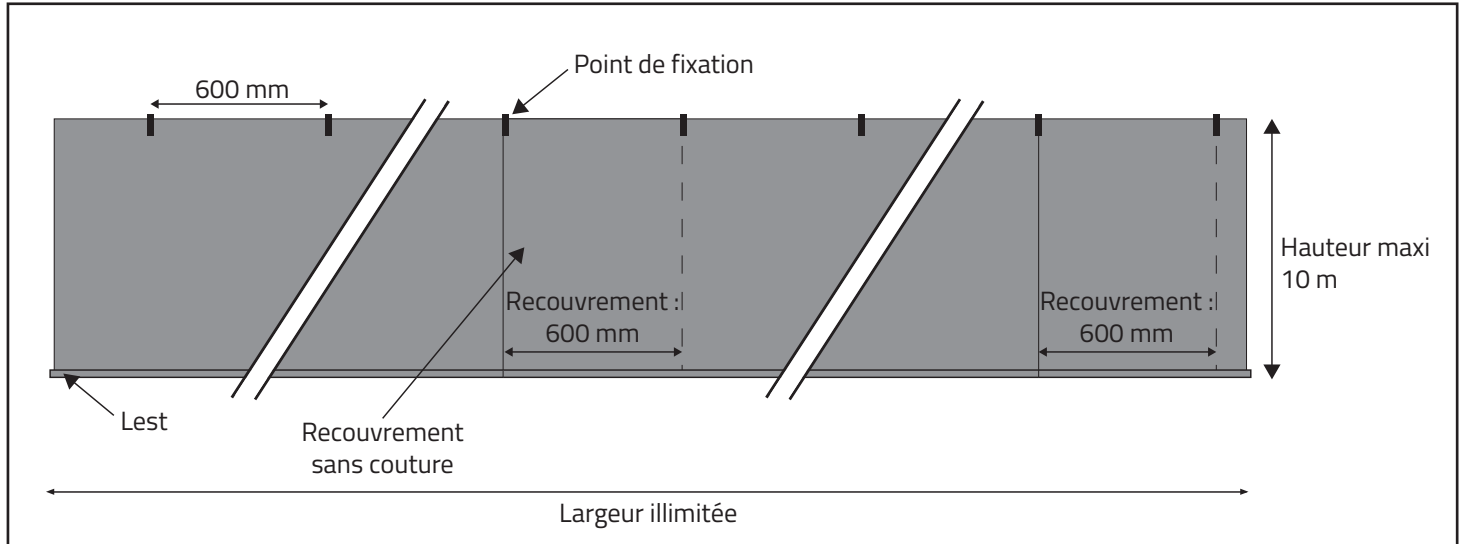
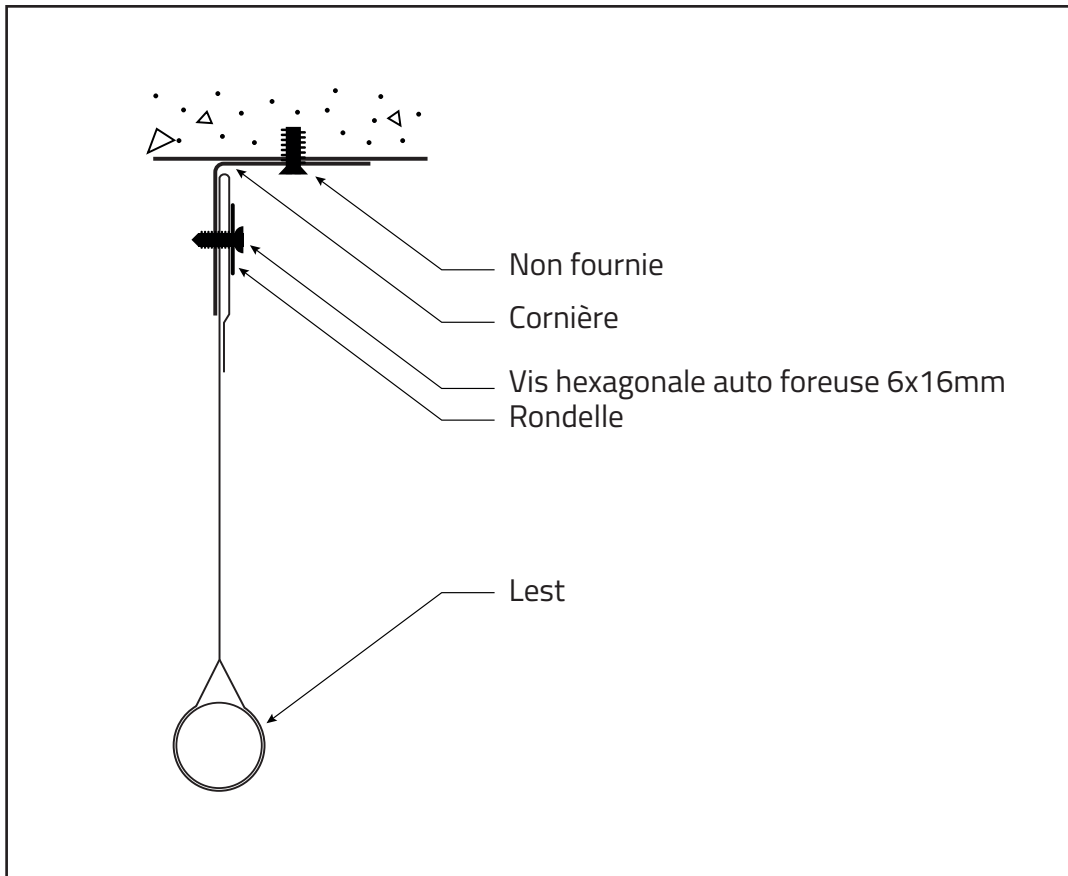

1 Fixer les cornières sur la structure (acier/béton).

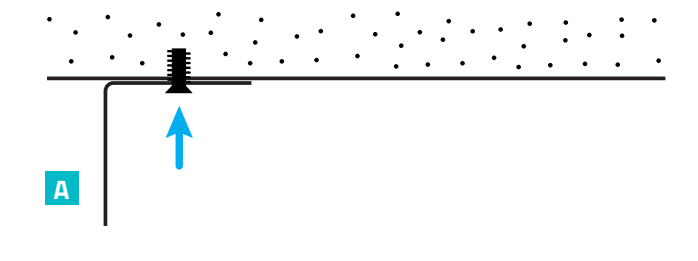

A Cornière 40x40x1,2mm

2 Tous les 600mm, fixer la toile sur les cornières avec les vis auto foreuses (6x16mm) et leurs rondelles.

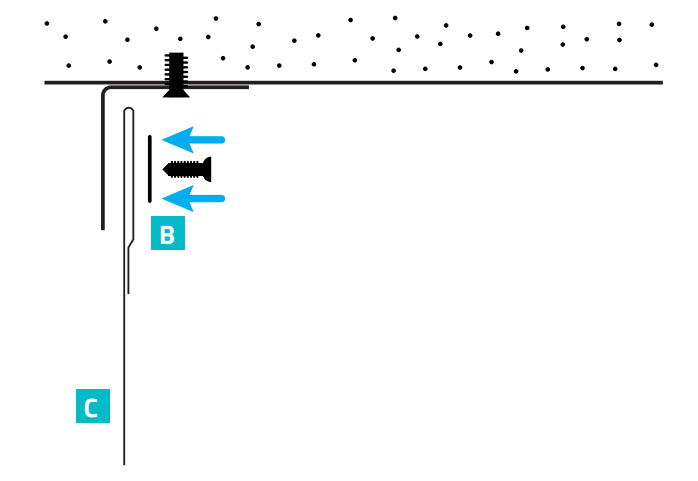

B Vis hexagonale autoforeuse 6x16mm

B Rondelle

C Toile souple

3 Insérez les barres de lestages dans les ourlets bas.

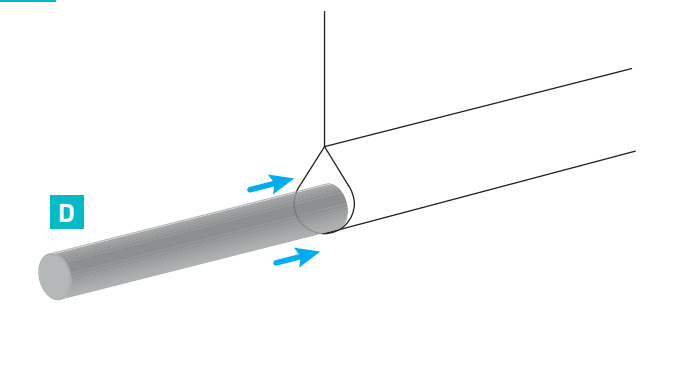

D Barre de lestage Ø 16 mm

4 Placez les manchons entre chaque barre de lestage.

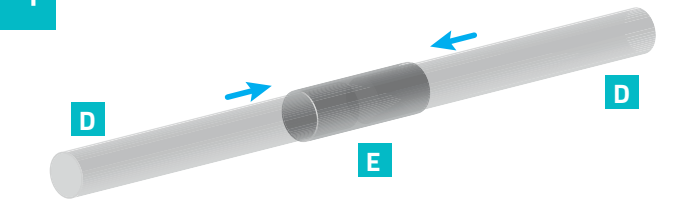

D Barre de lestage Ø 16 mm

E Manchons Ø 17 mm

5

Les écrans de cantonnement sont livrés avec un rouleau adhésif, utilisez-le pour les finitions.

F Adhésif

F



Repérage

Une étiquette de repérage est située en partie basse de l'écran de cantonnement, du côté le plus haut de celui-ci.

