

(3A) partiel (serrage colerette avant compression)

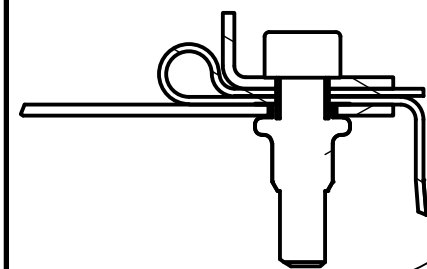

Sur-costiere

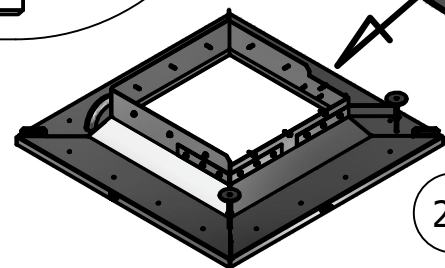

2A

ADIAOPN0020
Sur-Costiere avec crosses

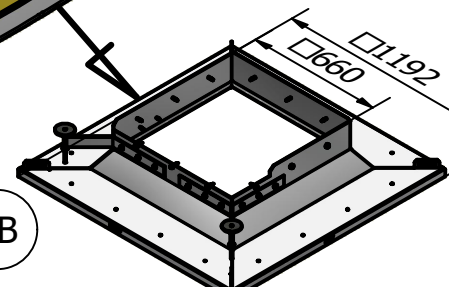

2B

ADIAOPN0026
Sur-Costiere sans crosse

ADIAOPN0027
Cadre de serrage
partie Haut

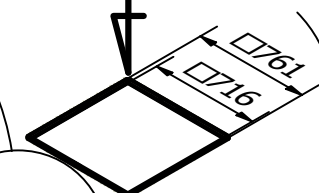

ADIAOPN0028
gaine textile
hauteur standard

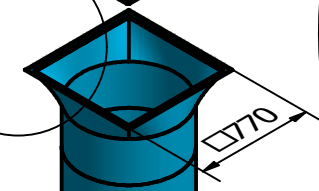

complément
ADIAOPN0029
ajout de gaine

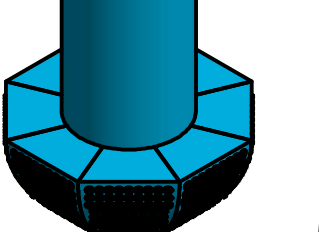

3A

ADIAOPN0027
Cadre de serrage
bas sous colerette

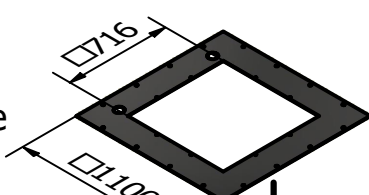

Costiere

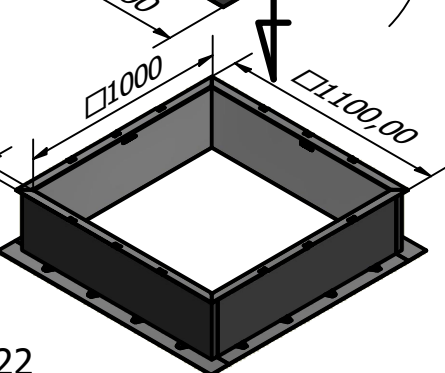

4A

ADIAOPN0022
Costiere isolé Droite
pose à plat (C100)

caisson traversant
hors fourniture

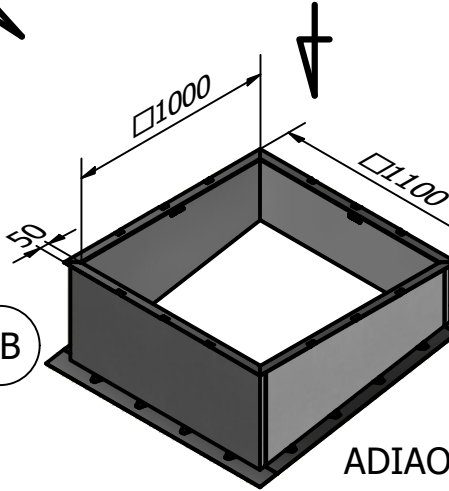

4B

ADIAOPN0021
Costiere isolée avec
rattrapage de pente
(C100)

Adiabox
WFP16000
1

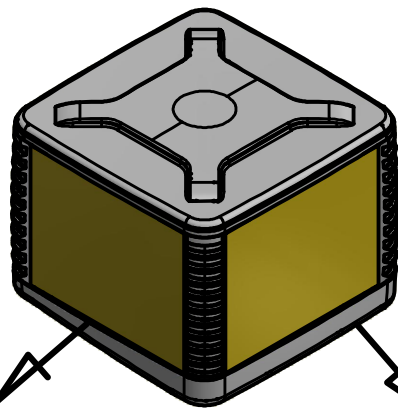

(1+2A)

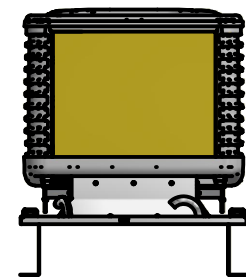

(1+2B)

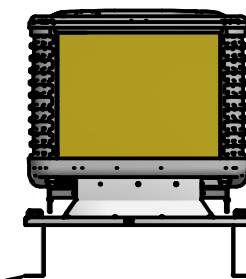

(1+2B+4A)

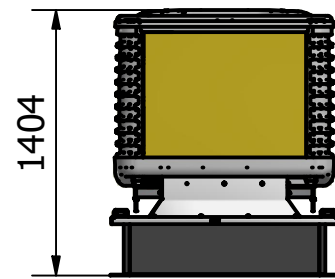

1404

(1+2B+4B)

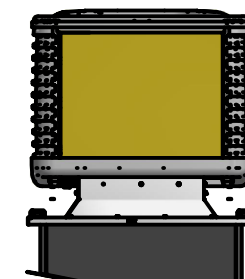

(1+2A+3A)

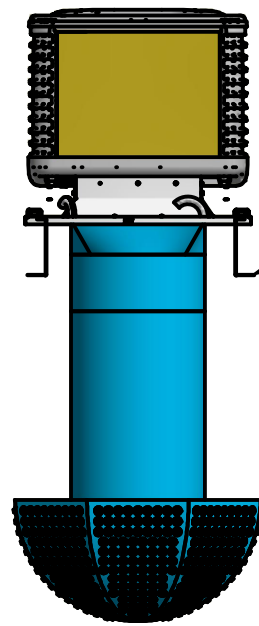

(1+2B+3A)

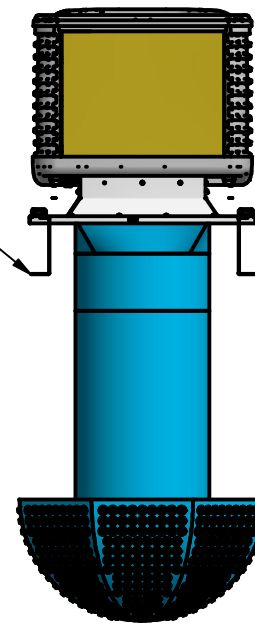

(1+2B+3B+4A)

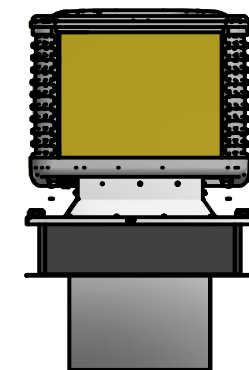

(1+2B+3B+4B)

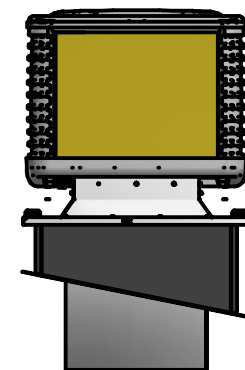

ADIAOPN0025 KIT Complet 16000

Costiere client

Arrivée
Puissance
pilotage

2A

Arrivée
eau

(1+2A+3A+4A) (1+2A+3A+4B) (1+2B+3A+4A) (1+2B+3A+4B)

1094
2140
3234

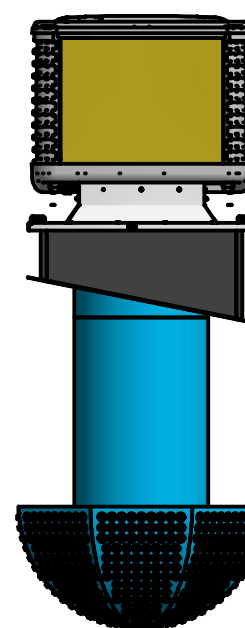
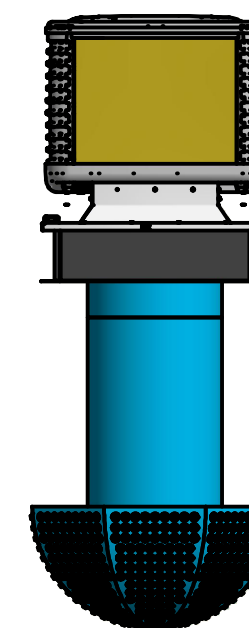
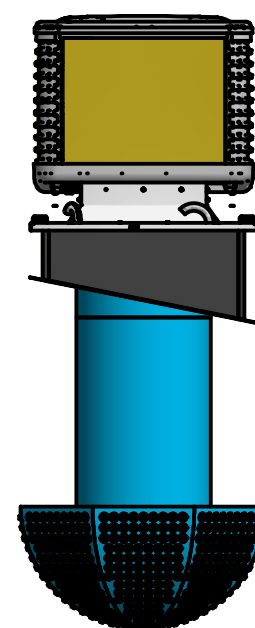
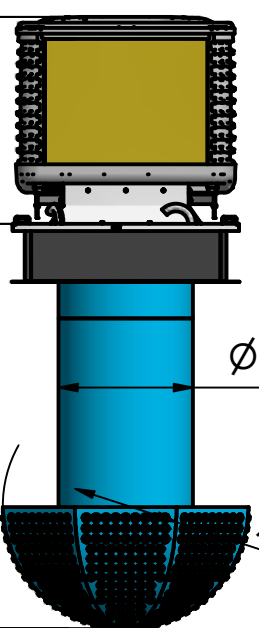

Ø710

Ø1300

Ce plan est notre propriété et ne peut être copié ou communiqué à des tiers sans notre autorisation © Copyright SOUCHIER-BOULLET SAS

WFP16000D Gamme Adiabatique

Date: 05/04/2022

genatis
Généraliste des Énergies Naturelles

Par Segro - 42 rue Lamirault
77090 COLLEGIEN - FRANCE

Tél. + (33) 01 60 37 79 50
Fax + (33) 01 60 37 79 89

Ech: SANS

Ind: Ø

CT34-ADIA-00