

VANTAUX ÉGAUX

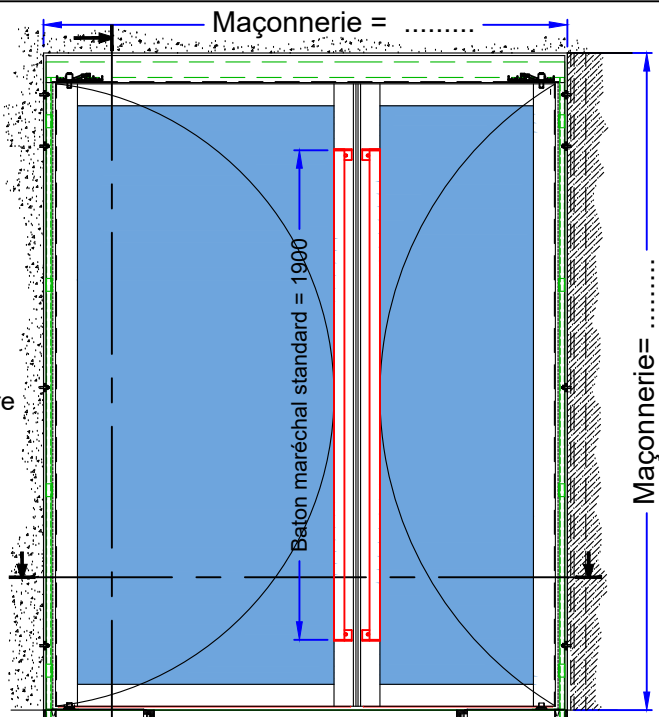

VANTAUX INÉGAUX

400 - Pivot MODE 1
430 - Pivot MODE 2

Voir planche de quincailleries - B812

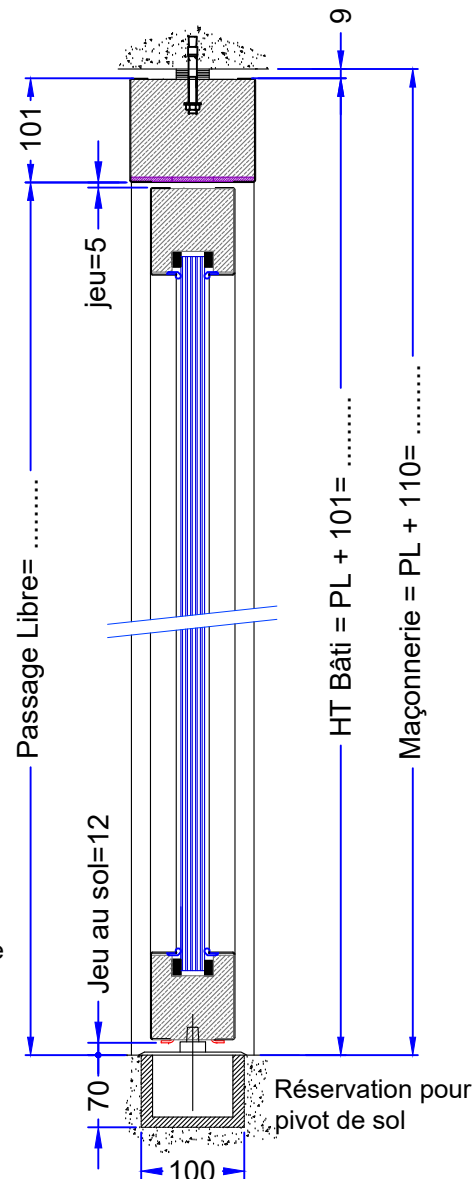
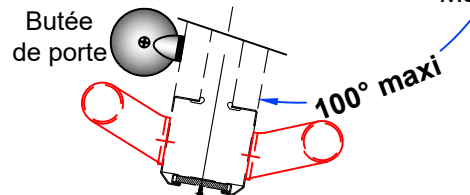
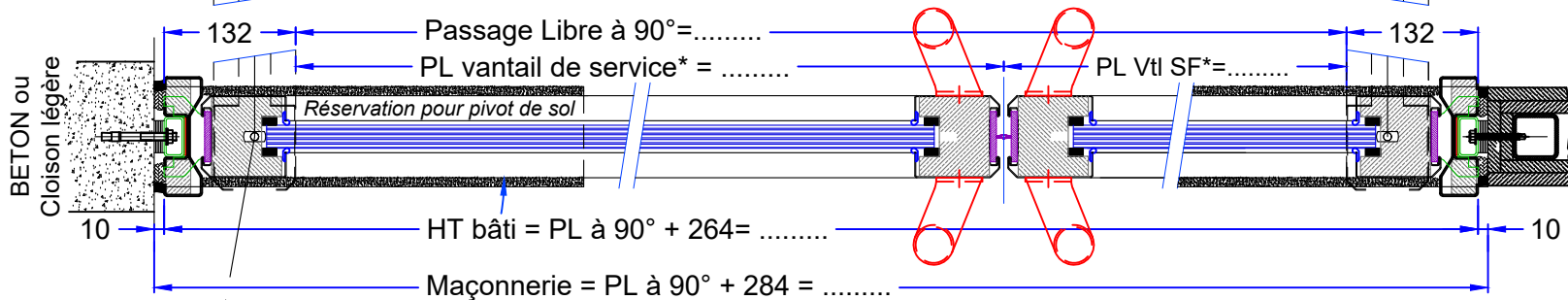
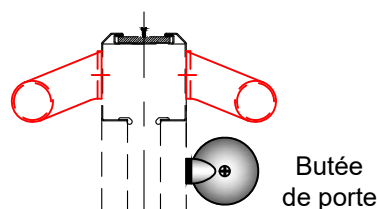
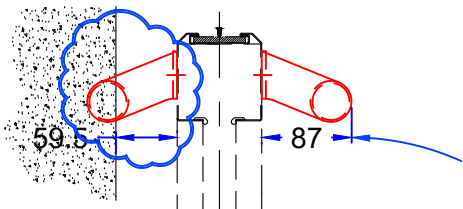

* variable suivant le degré de résistance au feu; le MODE de fonctionnement et les quincailleries
Maxi = 1020 / Mini = 392

Ind A - 08-10-14 - Ajout butée

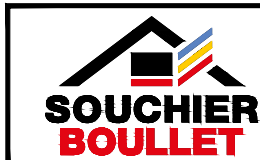

11 rue des Campanules CS30066
- 77436 Marne-la-Vallée Cedex 2
Tél. : 01.60.37.79.50 - Fax : 01.60.37.78.89

Réserve maçonnerie
PVV 2V - T114
BATI A VISSER
Pivot SOL - FP applique

n° plan :	B790-1	Ind :	A
Date :	23-02-11	Echelle :	/
PV :	11-V-228 / 11-A-517		
Dessinateur :	A. TROSLARD		

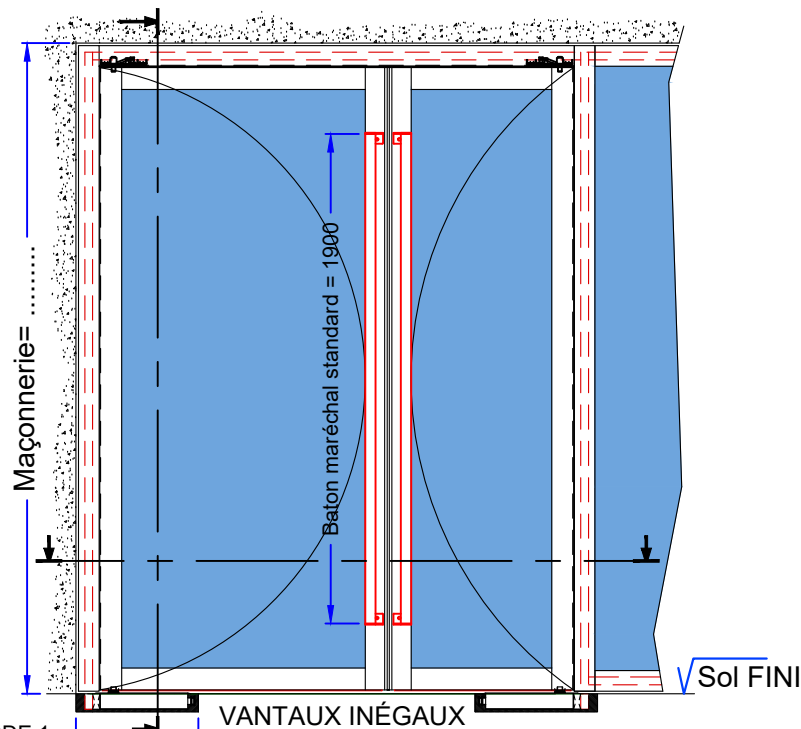

440 - Pivot MODE 1
475 - Pivot MODE 2

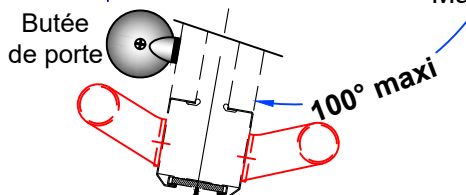
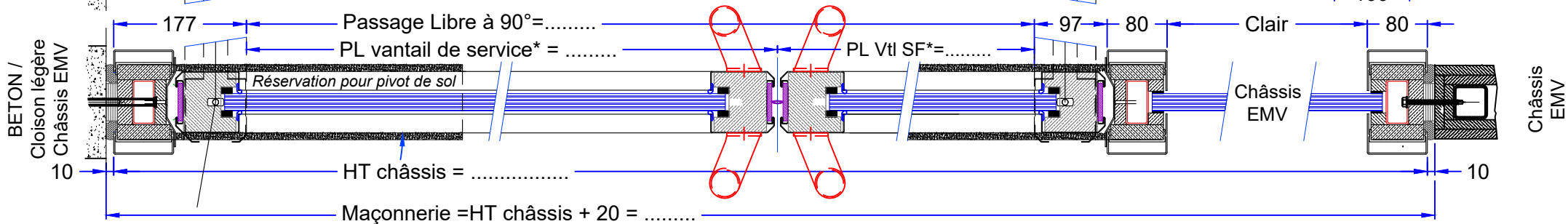
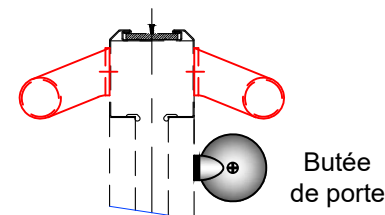
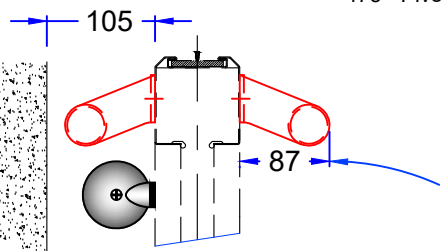
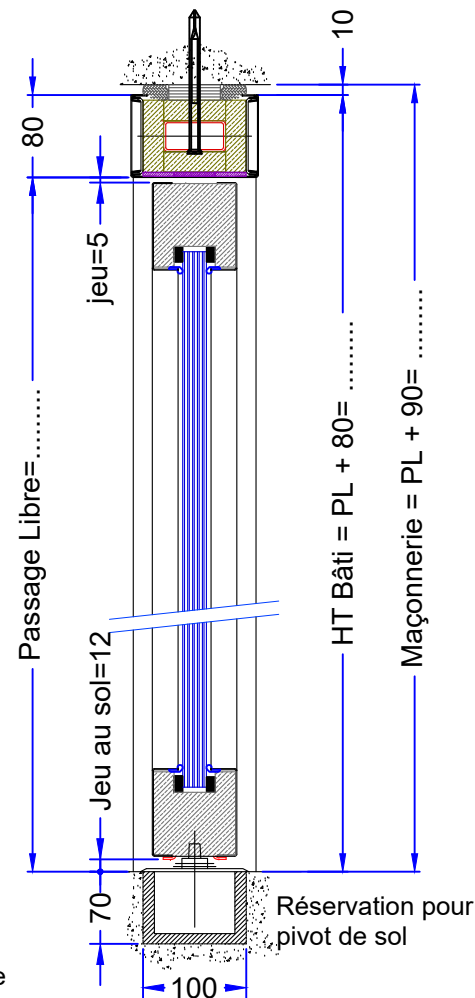

* variable suivant le degré de résistance au feu; le MODE de fonctionnement et les quincailleries Maxi = 1020 / Mini = 392

Ind A - 08-10-14 - Ajout butée

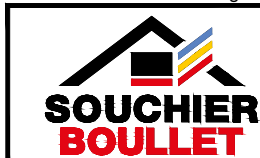

11 rue des Campanules CS30066
- 77436 Marne-la-Vallée Cedex 2
Tél. : 01.60.37.79.50 - Fax : 01.60.37.78.89

Réservation maçonnerie
PVV 2V - T114
Intégration EMV
Pivot SOL - FP applique

n° plan : B790-2	Ind : A
Date : 23-02-11	Echelle : /
PV : 11-V-228 / 11-A-517	
Dessinateur :	A. TROSLARD

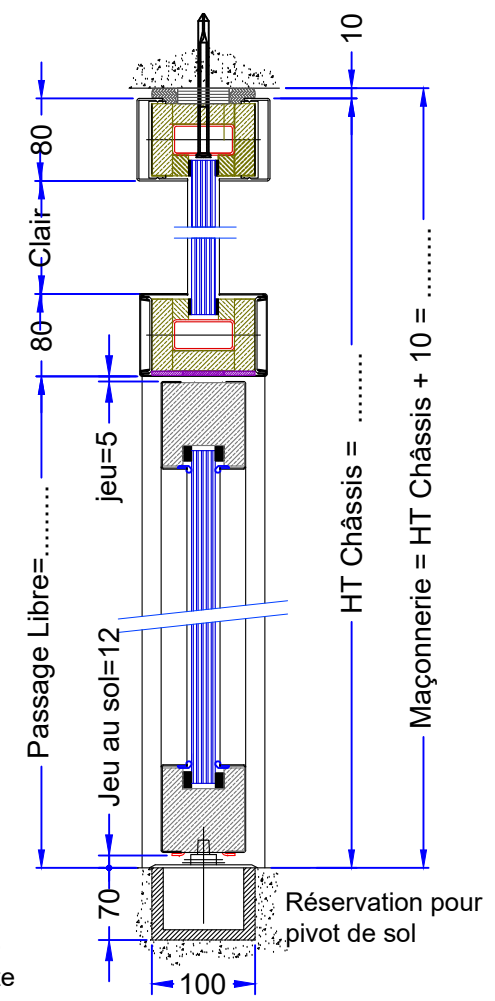
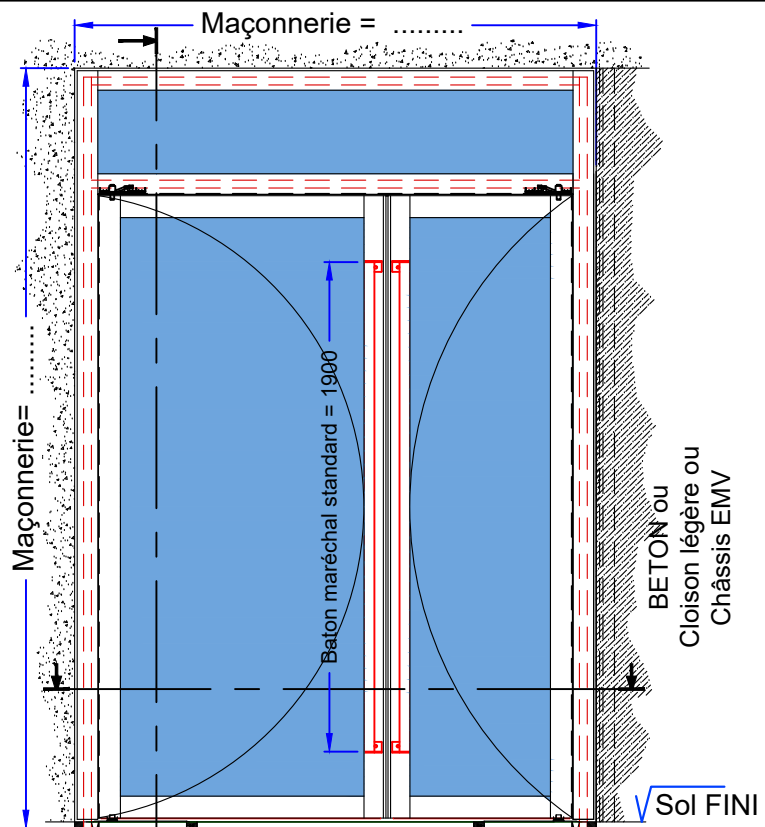

VANTAUX ÉGAUX
OU INÉGAUX

440 - Pivot MODE 1
475 - Pivot MODE 2

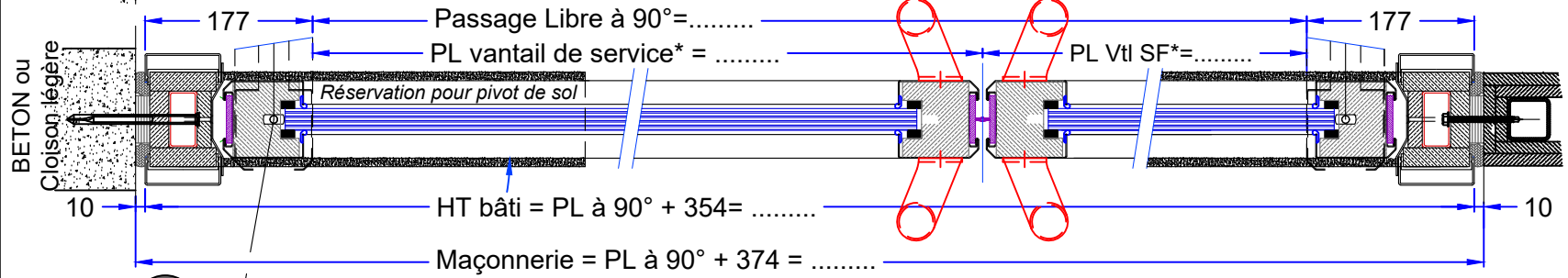
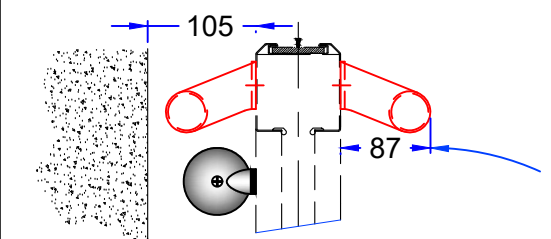
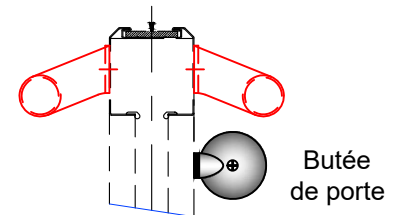

* variable suivant le degré de résistance au feu; le MODE de fonctionnement et les quincailleries
Maxi = 1020 / Mini = 392

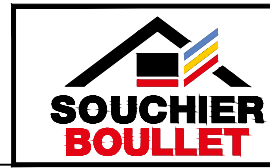
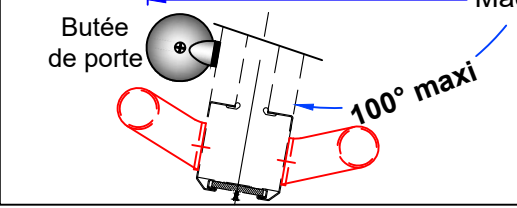

11 rue des Campanules CS30066
- 77436 Marne-la-Vallée Cedex 2
Tél. : 01.60.37.79.50 - Fax : 01.60.37.78.89

Réservation maçonnerie
PVV 2V - T114
Intégration EMV + imposte
Pivot SOL - FP applique

Ind A - 08-10-14 - Ajout butée

n° plan : B790-3	Ind : A
Date : 23-02-11	Echelle : /
PV : 11-V-228 / 11-A-517	
Dessinateur : A. TROSLARD	